

GAUGE SIPHONS GSC - GSU

DESCRIPTION

The GS series pressure gauge siphons were designed to protect pressure gauges from the effects of sudden pressure surges and hot pressurized fluids.

They operate as cooling elements for liquids and gases in pressure measuring devices.

An isolation pressure gauge cock is recommended to be installed in combination with gauge siphons.

MAIN FEATURES

Complete stainless steel construction.

OPTIONS: Different types of connections.

USE: Pressure gauge protection on steam, water, compressed air and other fluid systems compatible with the construction.

AVAILABLE MODELS: GSC-40; GSU-40 ; GSUL-40.

SIZES: G1/2" (male x female).

CONNECTIONS: ISO 228-1.

INSTALLATION: GSC – vertical; GSU – horizontal.

LIMITING CONDITIONS: 40 bar at 300 °C; 110 bar at 110 °C.

WEIGHT: 0,34 kg.

MATERIALS: Coil – AISI 316L / 1.4404.
 Connections – AISI 304 / 1.4301.



GSC



GSU



GSUL

DIMENSIONS

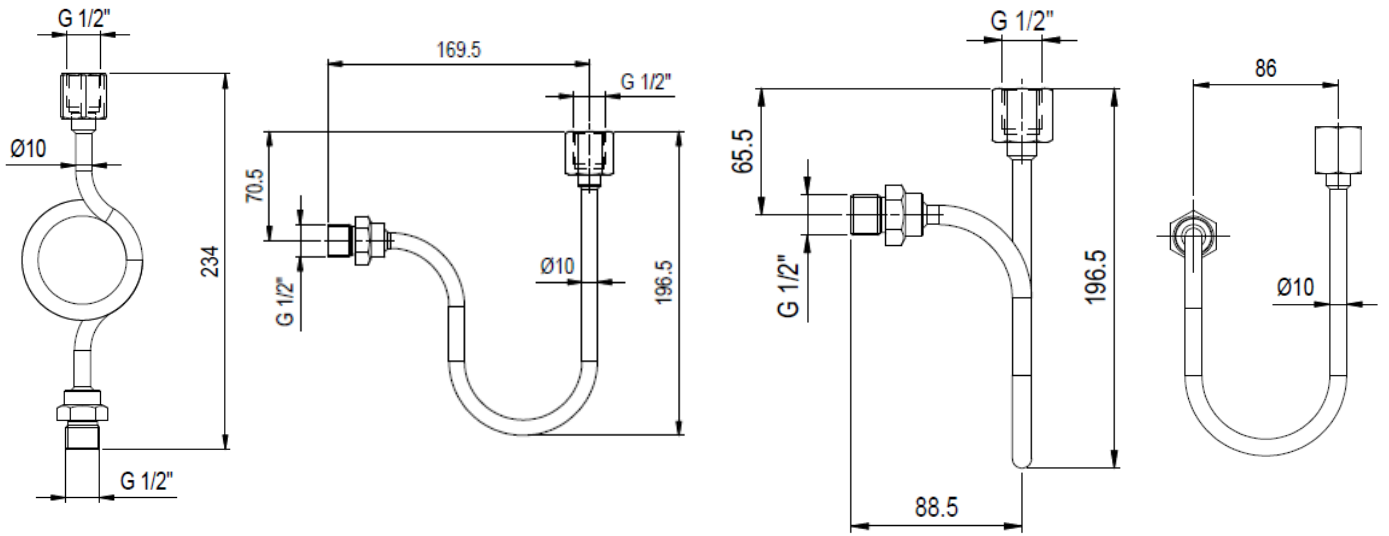

TYPICAL INSTALLATION

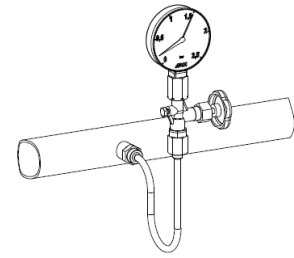
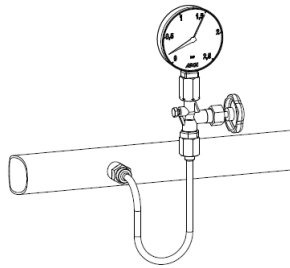
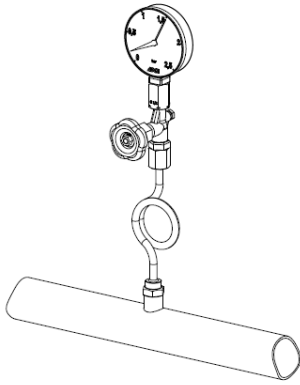

Horizontal pipes

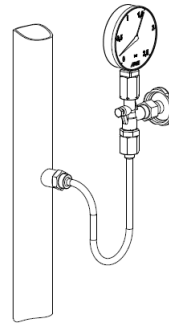
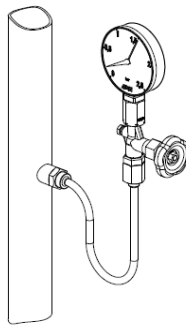

Vertical pipes

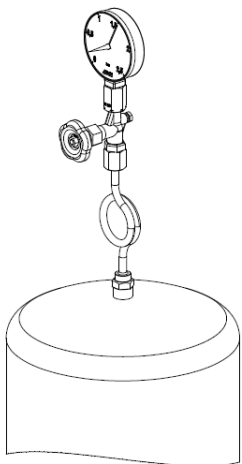

Top of vessel

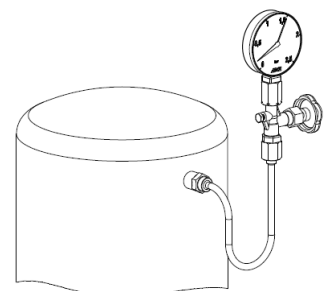
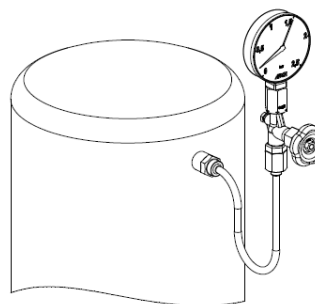

Side of vessel